



- PIN Access
- Mechanical Pushbutton Lock
- Single Access Code
- Cylindrical
- Lever

Features

Access Control:	Mechanical pushbutton lock—eliminates problems and costs associated with issuing, controlling, and collecting keys and cards. Provides exterior access by combination, while allowing free egress.
No Battery:	Fully mechanical lock eliminates the material and labor expense of battery replacements
Locking Device Options:	Cylindrical latch with 3-hour UL/ULC fire rating on "A" labeled doors
Number of Codes:	Single access code—one easy to manage code for all users
Programming:	Lock is easily programmed via keypad without removing lock from the door
Handing:	Factory-handed; not field reversible
Key Override (Optional):	Small format interchangeable cores, large format removable cores
Operation Modes:	Single credential—access Passage (select models)—Allows access without using the lock entry code Feature activated from the inside with a thumbturn or key (included with all passage feature models) Privacy (select models)—Disables the lock from the inside so that the entry codes can not be used to gain access. Access is permitted using the key override only when in this mode.
Economical:	A cost effective access control solution

Mechanical Features

Construction:	Heavy-duty cylindrical lock housing with cast front housing, unified trim plate, and fixed ADA-compliant levers
Numeric Keypad:	Vandal resistant, solid metal pushbuttons
Handing:	Factory-handed; not field reversible
Standard Finishes:	Satin Chrome 26D (626), Antique Brass 05 (609)
Optional Finishes:	Bright Brass 03 (605), Bright Chrome 026 (625)
Backset:	2 3/4" (70 mm), 2 3/8" (60 mm)
Latch:	1/2" (13 mm) throw latch; 3/4" (19 mm) throw latch (optional)
Minimum Stile Recommended:	5" (127 mm)
Weight:	8.25 lbs. (3.7 kg)
Strike:	Standard strike plate; ASA strike plate

Key Override

Interchangeable Cores:	Small format–Best and equivalents (6 or 7-pin length)
Removable Cores:	Large format–Medeco/ASSA/Yale (5 or 6-pin length), Corbin Russwin, Schlage, and Sargent

Installation

Door Preparation:	Easily installs on wood or metal doors. ASA 161 door preparation with additional through holes
Door Thickness:	1 3/8" (35 mm) to 2 1/4" (57 mm)–Pre-assembled to accommodate 1 5/8" (41 mm) to 2" (51 mm) doors
Items Supplied Include:	Lock assembly, installation manual, full-scale template, combination change plug and access key, and required installation hardware

Certification and Testing

Accessibility Standard:	Americans with Disabilities Act (ADA)
Durability:	Compliance with D.O.D. 5220.22M; highly weather resistant
Fire Rating:	3-hour UL/ULC fire rating for "A" labeled doors

Warranty

Warranty:	3-year warranty
------------------	-----------------

Cylindrical

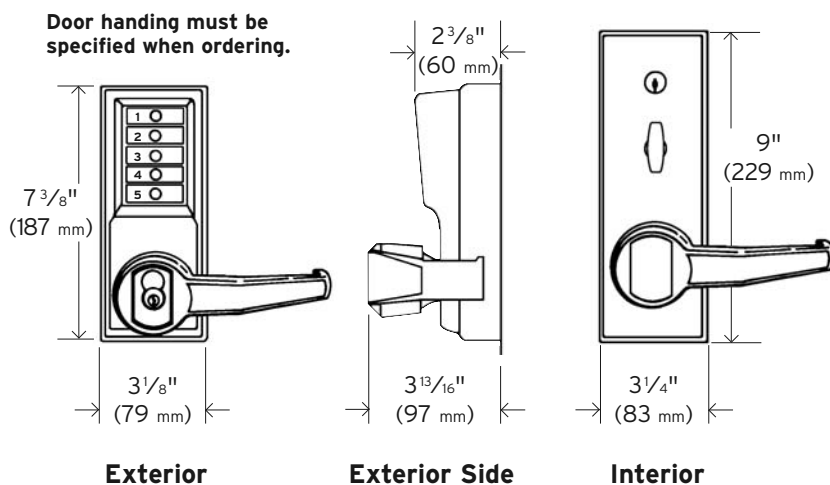

Model L1011

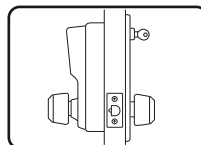

- Combination Entry
- Interior Combination Change

Model L1021

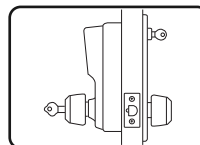

- Combination Entry
- Key Override (not supplied)
- Interior Combination Change

Model L1031

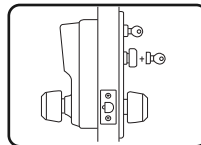

- Combination Entry
- Interior Combination Change
- Passage

Model L1041

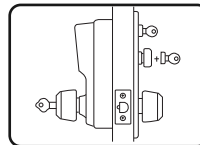

- Combination Entry
- Key Override (not supplied)
- Interior Combination Change
- Passage

Model L1076

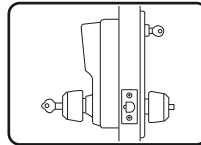

- Combination Entry
- Key Override (not supplied)
- Interior Combination Change
- Privacy (Lockout)

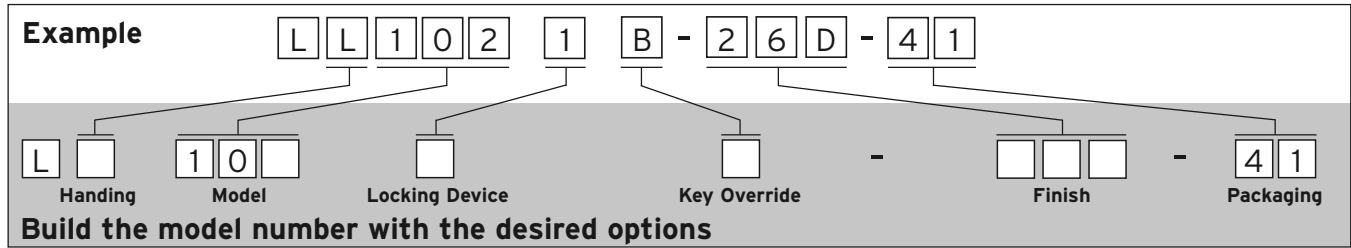

Base Model	Description
LL101126D41	Cylindrical Lock with Lever, No Key Override

Key Override Options+	Description
B	I/C Best and Equivalents (6 or 7-pin Length)
C	R/C Corbin Russwin
M**	R/C Medeco/ASSA/Yale (5 or 6-pin Length)
R	R/C Sargent
S	R/C Schlage

Choose one option from each category

Handing Options	Description
L	Left Hand or Left Hand Reverse
R	Right Hand or Right Hand Reverse

Function Options	Description
1	Combination Entry Only
2	Combination Entry and Key Override
3	Combination Entry and Passage
4	Combination Entry, Key Override and Passage
7	Combination Entry, Key Override and Privacy (Lockout) (Requires "6" Locking Device Option)

Finish Options	Description
026	Bright Chrome (625)
03	Bright Brass (605)
05	Antique Brass (609)
26D	Satin Chrome (626)

Locking Device Options	Description
1	Cylindrical ½" (13 mm) throw latch, floating face plate, 2 ¾" (70 mm) backset (UL listed)
2	Cylindrical ½" (13 mm) throw latch, floating face plate, 2 ⅜" (60 mm) backset (UL listed)
5	Cylindrical ¾" (19 mm) throw latch, beveled face plate, 2 ¾" (70 mm) backset (UL listed)
6	Cylindrical ¾" (19 mm) throw latch, beveled face plate, 2 ¾" (70 mm) backset (UL listed)

Notes

+ **Interchangeable/Removable core cylinders are not included with the lock**

** **Medeco/ASSA/Yale (5 and 6-pin length)**
5 and 6-pin Medeco/ASSA cylinders require a special knob spacer (Included in Package).