















**KABA**<sup>®</sup>

# Kaba E-Flash EF110

Electronic Rim Lock

# E-Flash EF110 Electronic Rim Lock

-  Up to 20 users
-  Proximity card identification or key chain fob
-  Missing key invalidation
-  Easy re-registration of keys
-  Break-in damage alarm
-  Wrong-try lock out delay
-  Automatic lock mode with manual override
-  Retrofits in place of existing door locks
-  One touch wake up
-  Low battery power and malfunction alert
-  Emergency access power supply
-  Etiquette audio mode
-  Remote control (optional)



## Tailored Flexibility

The E-Flash EF110 is the ideal electronic lock for residential access solutions. No more lost or stolen keys the EF110 eliminates the need for keys and allows multiple users to be programmed into the lock.

The one-touch operation of the EF110 enables simplicity of lock functions for all users.

Optional wireless door release (remote control) provides added flexibility to the system.

## Product characteristics

The EF110 provides the convenience of security code access, proximity card and fob (mobile strap key) access.

Quick one-touch wake-up access control ensures easy use and enhanced battery life for minimal maintenance.

A built-in self-diagnostic function alerts the user of any potential malfunctions or damage.

The EF110 has an automatic lock mode with manual override.

## Construction

The durable construction materials including steel mortice lockcase, zinc and aluminium castings and high impact fibre glass resin ensure high strength within the system

## Installation

The EF110 retrofits in place of existing door locks.

## Applications

- Residential Properties



Stylish electronic keypad - illuminated



Internal lock/unlock function



Manual knob unlock function

# E-Flash EF110 Electronic Rim Lock

## Technical data

- Energy supply: 4 x 1.5V AA size alkaline batteries - emergency power supply via 9V battery.
- Self-checking system: In case of malfunction or low battery power the system will alert the user.
- Break-in/Damage alarm: An alarm will sound if anyone attempts to damage the lock or forces the door open. The alarm can be set to 3 time lengths of: 3 minutes, 10 minutes or 30 minutes
- Wrong Try Lock-out: If incorrect code is entered 5 times in a row all functions shut down for 3 minutes.
- Volume Control: In Etiquette Mode no sound is made during normal function- however the break-in alarm still operates.

- Number of user media: 2 card keys and 2 fobs (mobile strap keys) are provided up to max. 20 card key/mobile strap keys can be registered.
- Door Thickness: suitable for doors up to 50mm maximum thickness - accessories are required for thicker doors.
- This product is designed to be used only indoor and weather protected outdoor areas.
- Operating Temperature -15°C to 55°C (5°F to 131°F).

## Programming

Access privileges can be programmed and managed with:

- Card Key registration: press the **ⓘ** button and contact all of the keys you wish to use one by one, then press the **ⓘ** button.
- Security Code registration: Press the **ⓘ** button and enter your security code (4-12 digit number) then press the **ⓘ** button.

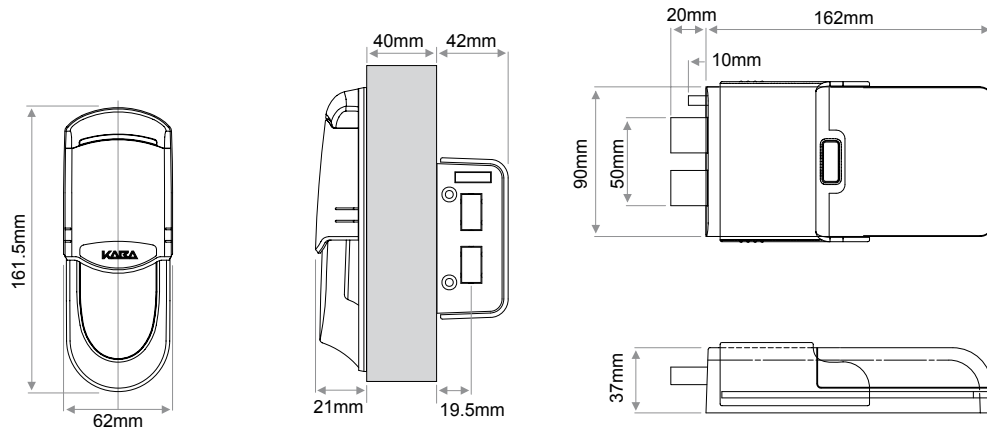

## E-Flash Accessories



Wireless Door Release (remote control)



Card Keys



Fob (mobile strap key)



**Kaba Limited**  
2108 Futura Plaza  
111-113 How Ming Street  
Kwun Tong, Kowloon, Hong Kong  
Tel. : +852 2375 6110  
Fax : +852 2406 2602

**Macau**  
Toll Free Number : +0800 348

Email : [sales@klh.kaba.com](mailto:sales@klh.kaba.com)  
[www.kaba.hk](http://www.kaba.hk)